



The Eyes of Science

... *i*magine microscopy in perfect comfort



**ECLIPSE**  
**50*i* / 55*i***



Imagine the ultimate in comfortable microscopy operation; so comfortable, that you would not even be aware you were carrying out essential observations!

After carefully listening to customer needs, Nikon designed the new 50i/55i series of compact, versatile microscopes that are ideal for clinical/laboratory inspection and basic research study.

The ultimate in usability and comfort, the 50i/55i series incorporates a host of stunning features that take the stress out of microscopy. A stage with height adjustable handle and tilting/telescoping ergonomic eyepiece tube ensure ideal viewing posture, enabling long hours of observations to be carried out in perfect comfort.

The 50i/55i series is built around Nikon's tried and tested infinity optics, the CFI60 system, which means you not only get the optimum optical performance, but you also have the freedom to add various accessories to create the setup that best suits your purpose.

## 50i/55i

... the ultimate comfort that takes clinical microscopy to new heights.

— Cool illumination (55i)—LED illumination generates no heat and maintains the color temperature even when the brightness is changed. Also, because this model can run on batteries, it can be used anywhere. (See page 4)

— New stage with smooth movement makes frequent stage movement accurate and effortless. The stage handle height can be adjusted for easy operation. (See page 4)

— A digital camera can be mounted on the ergonomic eyepiece tube by using a DSC port, enabling easy digital documentation in a comfortable operating posture. (See page 6)

— The "Ergo-View," a retrofittable compact cytodiagnostic unit, enables quick magnification changeover using a hand switch. (See page 7)

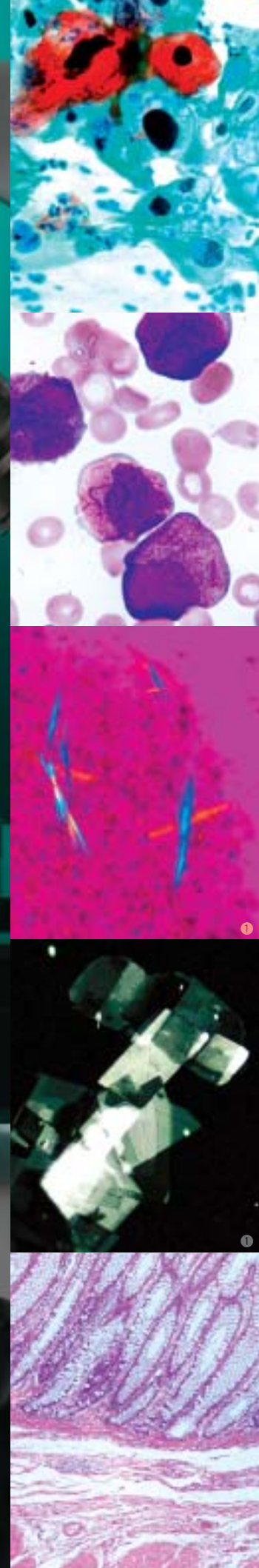

... in harmony with you

### Cool illumination (55i)

Utilizing white LED illumination, the 55i is an ideal choice for brightfield applications. As the color temperature does not change even when the brightness is altered, adjusting the color balance filter or voltage is no longer necessary. And because the LED illuminator is built into the base, comprehensive Koehler illumination using a diaphragm is possible. The illuminator does not generate heat. Due to its minimal power consumption, the 55i has an extremely long lamp lifecycle, and its battery drive means it can be used anywhere.



### New ergonomic tube

The new ergonomic tube can be inclined from 10° to 30° and the eyepieces can be extended 40mm. This ensures optimum eye point and a comfortable viewing posture, regardless of the operator's physique or if intermediate modules are being used. An optional DSC port for attaching a digital camera enables users to create a digital documentation system in comfort. An optional eye-level riser\* can raise the eye point in 25mm increments.

\*The number of risers that can be used at any one time depends on the intermediate modules being used.



Viewing angle is adjustable 10°–30°.



Eyepiece length is extendable up to 40mm.

### Refined stage

#### Smooth and accurate specimen movement

The highly precise XY stage movement accurately responds to delicate adjustments of the stage handle. Frequent stage movement in pathology and diagnostic cytology can be conducted easily with the fingers. The compact design features a unique stage handle extension mechanism that allows adjustment of stage handle height for ease of use.



#### Hardened finish

Special hardened finish protects stage surface from scratches caused by repetitive changing of glass slide specimens.

#### Refocusing stage

The stage can be lowered by pushing the lever down, and will return to its former height when the lever is pressed again. This feature eliminates the need to refocus the image manually each time the specimen is changed and the slide oiled, greatly improving microscopy productivity.



### Easy-access controls

Frequently used controls and switches for adjusting the field diaphragm and illumination intensity have been concentrated in the lower part of the righthand side to minimize the operator's hand movements and enable operation without having to take your eyes off the specimen.



### Rock-solid stability

Utilizing computer-aided engineering (CAE), Nikon has successfully increased the solidity of the microscope body and produced a sleek, modern design. Although compact in size, the new microscopes boast superb durability and stability, even during applications in which they are upgraded with various attachments.



## ECLIPSE 55i

— With white LED illumination as its light source, this model is perfect for brightfield applications.

— No color temperature deviation even when brightness is changed.

— Cool LED prevents focus deviations caused by heat-deformed equipment.

— When Ergo-View cytodiagnostic unit is installed, it maintains uniform brightness even if magnifications are changed.

— Long lifecycle illumination consumes very little power.

— Battery-drive capability using optional lithium batteries means model can be used anywhere.

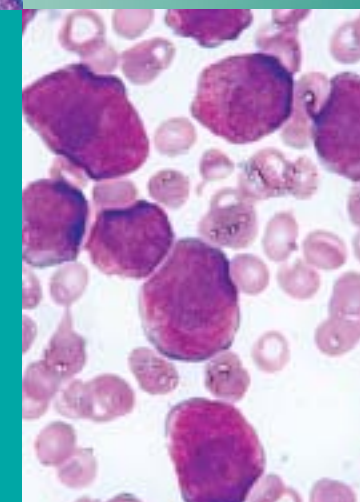
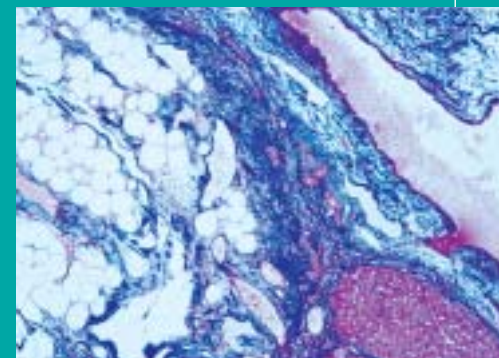

## ECLIPSE 50i

— Bright 6V-30W halogen lamp as light source.

— ND8 filter is built-in as standard.

— Enables brightfield, darkfield, epifluorescence, phase contrast and simple polarizing observations.

... in harmony with your vision



**CFI 60—tried and tested infinity optics**

Highly acclaimed optics combine the CF design with infinity optics and utilize a 60mm parfocal distance, resulting in longer working distances and high N.A.'s, while producing crisp, clear images with minimal flare. The CFI 60 optics are perfect for both observations and capturing images with a digital camera, and they provide a flexible upgrade path to accommodate various accessories to meet individual applications.



**DSC port enables digital imaging in comfort**

A new optional DSC port can be combined with an ergonomic tilting/telescoping tube to balance user needs for both digital-image capture and comfortable viewing. Including a 0.7X lens that is designed to optimize the image to the 2/3-inch CCD, the same area as that viewed through the eyepieces can be captured with a C-mount digital camera. A centering and focus adjustment mechanism is also provided.

**DS-Fi1-L2 Digital Sight standalone digital camera**

The DS-Fi1-L2 camera incorporates a high-definition, 5-megapixel color CCD, offering a high dynamic range and superior red sensitivity. The camera system features a standalone camera-control unit that has a large, built-in LCD monitor. Optimal camera settings have been preprogrammed for each observation method and are selectable from the menu. Users can take advantage of the camera's network functions to send or share images over a network and manage images on a server, saving time and increasing productivity. The high-speed, 2-megapixel DS-2Mv-L2 is also available.

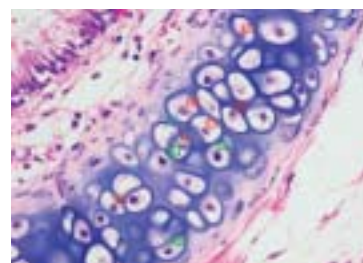

Count marking

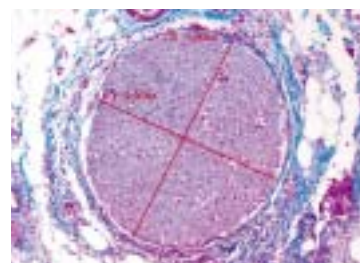

Distance measurement between 2 points



**Ergo-View enables quick magnification switching and marking**

The compact Ergo-View cytodiagnostic unit has been developed for easier and more comfortable cytology examinations. Retrofittable to the 50i/55i, it can quickly move between 10X and 40X at the flip of a switch, utilizing a motorized mechanism.

- Compact, sleek design.
- Easily attachable to 50i/55i.
- Fast and accurate motorized magnification changeover with hand switch.
- Unique quiet, vibration-free mechanism for magnification change ensures superb parfocality of images and no deviation in focusing.
- Easy marking while observing the specimen through eyepieces.
- Quick exchange of slides with one hand is possible by using an optional specimen holder for one slide.

**Constant brightness when combined with the 55i**

When the Ergo-View is mounted on the 55i, which utilizes white LED illumination, light intensity is automatically adjusted in conjunction with changes in magnification. Constant brightness is provided throughout the inspection, preventing eyestrain.

... in harmony with your hands

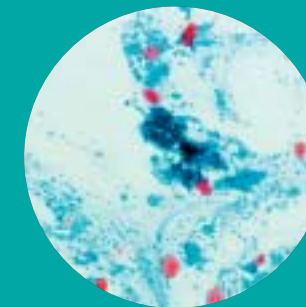

10X

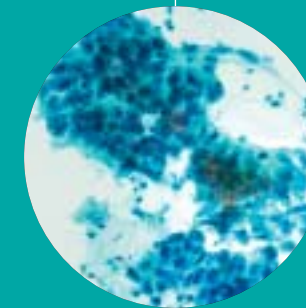

40X

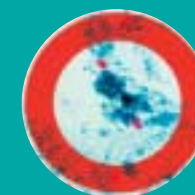

Change between 10X and 40X at the flip of a switch.



Marking is easily performed while observing the image. Quick-dry ink facilitates fast, clean marking.



# ... in harmony with your needs

## ... applying various methodologies

### Pathology tests

As the 55i model uses white LED illumination, it can maintain the same color temperature even if the brightness is changed. Observations extending to many hours can be carried out in a natural posture, without physical strain because an ergonomic tube enables the flexible adjustment of the eye point.



### Cytodiagnosis tests

The new Ergo-View cytodiagnostic unit makes magnification switching and marking faster and easier. When it is combined with the 55i model, changes in the amount of LED light are aligned with magnification changes, enabling observation at a constant brightness.

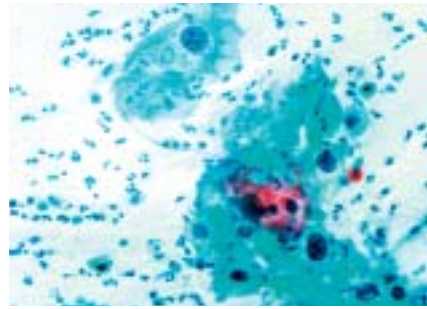

### Epi-fluorescence microscopy

A new dedicated turret-type epi-fluorescence illuminator has a quick-change mechanism combined with a unique filter-lock system and front-mounted shutter, providing the ultimate in clinical fluorescence diagnostic microscopy.

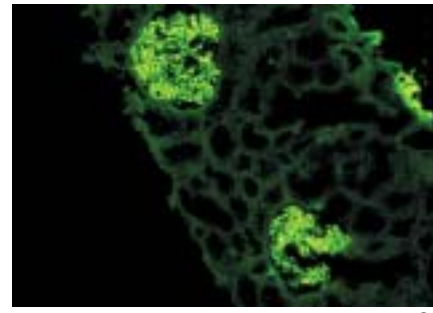

### Phase contrast microscopy (50i)

Developed expressly for this technique, our unique Apodized Phase Contrast objectives enable the detection of minute structures—previously difficult to detect due to annoying halos—with excellent contrast and a much wider tonal range. This is ideal for urinary sediment tests.

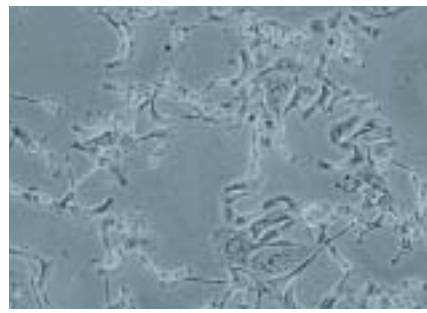

### Simple polarizing/sensitive color-polarizing microscopy (50i)

Simple polarizing microscopy can be performed easily using dedicated accessories. Sensitive color-polarizing microscopy enables uric acid crystals forming inside an organism to be identified by changing the interference color via a lever. Such microscopy is ideal for gout tests.

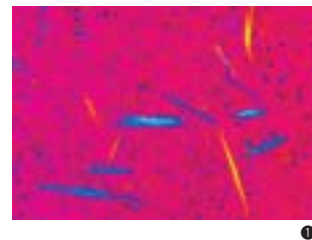

### Darkfield (50i)

Darkfield microscopy is ideal for observing specimens such as blood and the minute structures of flagella. A dry- or oil-type darkfield condenser can be selected.

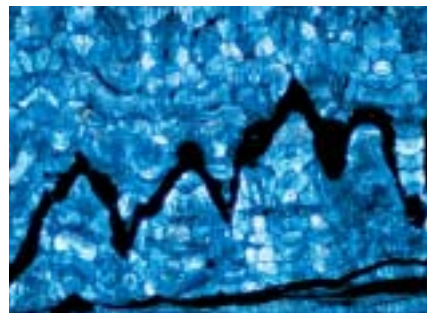

## ... and a wide range of accessories

New accessories complement a rich variety of existing accessories.

### Epi-fluorescence attachment

This dedicated turret-type epi-illuminator can accommodate four filter cubes despite its compact size. Filters or mirrors in the filter cubes can be easily replaced to create the desired combination. The attachment's glowing display tags make it easy to recognize filter names in a darkened room.



### Teaching head (50i)

These teaching heads, which come with a built-in pointer, facilitate simultaneous viewing of the same specimen by up to 5 persons without compromising image brightness.



2-person (side-by-side) version

### Double port

Mounted between the main body and eyepiece tube, the double port enables operators to use two CCTV camera systems simultaneously or one CCTV camera and one digital camera.



### Ergo-View cytodiagnostic unit

This compact cytodiagnostic unit can be easily retrofitted to the microscope. Changing magnification from 10X to 40X can be achieved at the flick of a switch.



### Eyepiece tubes

In addition to the ergonomic tube (see page 4), the following Eclipse series tubes are available.

Binocular tube B    Trinocular tube F2UW    Trinocular tube T2UW



### Eye-level riser

The eye-level riser can raise the eye-point height by 25mm at one time (up to 100mm\* maximum).

\*: The number of risers that can be used at any one time depends on the tube or intermediate modules being used.



### Magnification module

The magnification module allows the intermediate magnification to be changed to 1X, 1.25X, 1.5X or 2X, enabling the operator to frame the image to be captured with a digital camera to match the view field seen through the eyepieces.



### Drawing tube

The observation image and drawing can be seen together through the eyepieces. When necessary, 100% of the light can be sent to the observation port.



### DS-Fi1-L2 Digital Sight digital camera

This high-definition color camera delivers high dynamic range and superior red sensitivity. The standalone type control unit with a large, built-in LCD monitor allows high-definition images to be captured without being connected to a personal computer. "Scene Function" enables optimal camera settings for each observation method to be selected from the menu.



### Photomicrographic equipment H-III

This film camera features a direct-projection system with swing-out prism to ensure fast auto exposures and accurate metering.



### Lithium-ion battery (55i)

The optional lithium-ion battery increases the mobility of the 55i by freeing it of dependence on an electrical outlet.

### Simple polarizing set and sensitive color polarizing unit (50i)

These easily installed options enable operators to carry out simple polarizing/sensitive color polarizing observations.



Simple polarizing set



Sensitive color polarizing unit

# System Diagram

\*: 50i model.

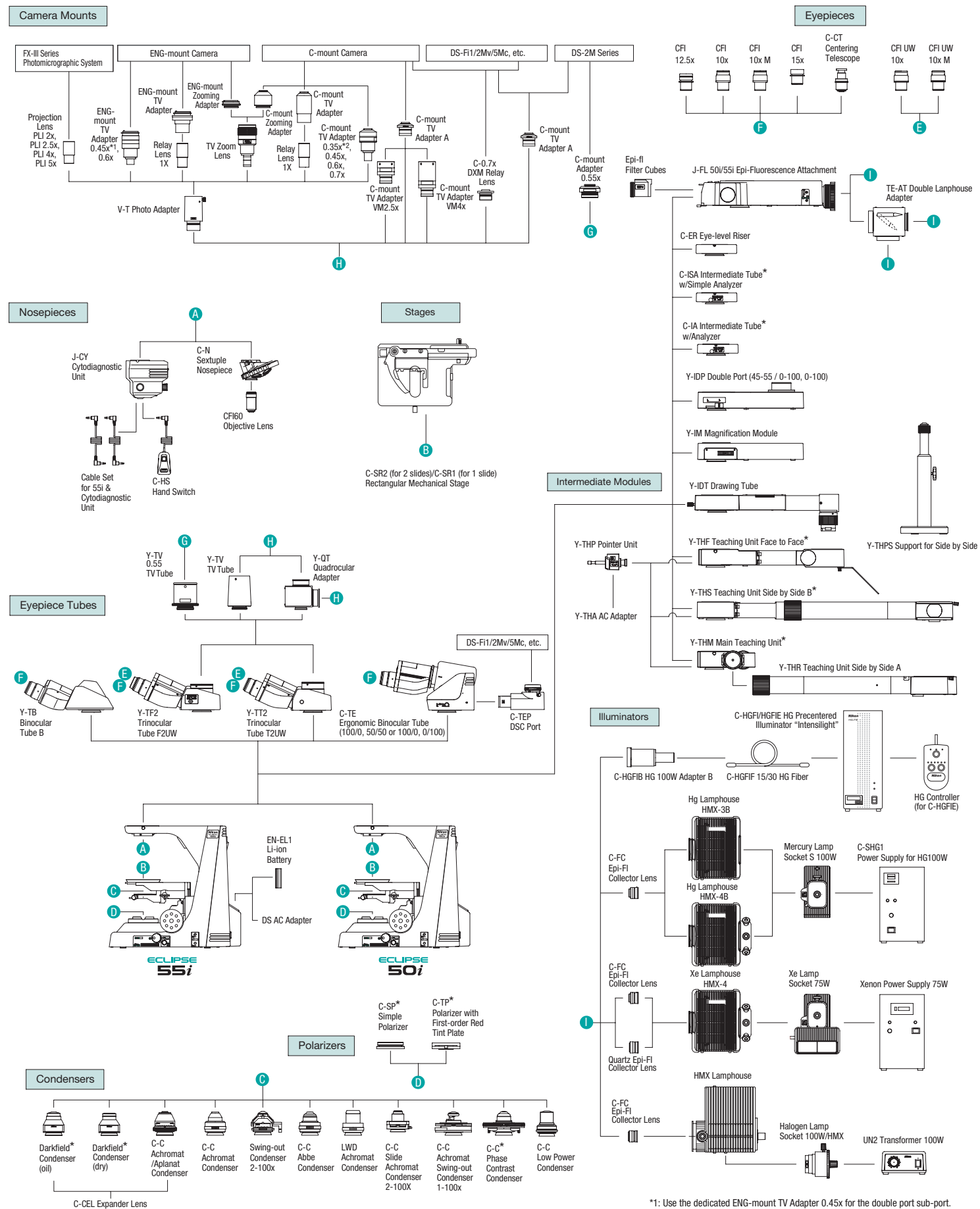

\*1: Use the dedicated ENG-mount TV Adapter 0.45x for the double port sub-port.  
 \*2: Use the dedicated C-Mount TV Adapter 0.35x for the double port sub-port.



Advanced research microscope  
**ECLIPSE 80i**

Built around an optimum digital-imaging platform, the 80i can visualize weakly fluorescing molecules with much higher brightness and contrast, while reducing background noise.

The new Plan Apo VC objectives and unique "fly-eye" optics guarantee uniform brightness over the whole view field and unparalleled resolution to the peripheries of the image. These remarkable achievements, which take digital imaging to new heights, are the result of Nikon's breakthroughs in optical technologies and precision engineering.

—Hi S/N Fluorescence System. The universal epi-fluorescence illuminator and digital-imaging head incorporate Nikon's unique Hi S/N Fluorescence System, which employs a "Noise Terminator" to achieve unparalleled contrast with excellent S/N ratios. An optional "Excitation Balancer" allows specific wavelengths to be emphasized in multi-stained specimens.

— Digital-Imaging Head. This creates an optimum digital-imaging system that enables fluorescence imaging with outstanding results. When the Digital Sight series digital camera is mounted to this head, observation data such as magnification and fluorescence filters in use is automatically detected and can be saved together with the image file.

— New DIC System. A perfect balance of high resolution and high contrast is possible, even at low magnifications. Three types of DIC prisms are available: standard, high-contrast, and high-resolution.

Nikon offers various options to best suit your digital-imaging needs



Digital microscope  
**COOLSCOPE II**

An all-in-one microscope that can be operated by mouse

In a simple all-in-one design, the COOLSCOPE II combines a microscope with a digital camera and network functions into the tower unit. All operations—from observation, image capture to network communications—can be carried out with simple mouse clicks. Thus, the COOLSCOPE II transcends the existing concept of a microscope.

— Once the glass slide is set, high-definition SXGA images can be viewed on the monitor in a relaxed and comfortable posture.

— Aperture and brightness are automatically adjusted, while stage movement, focusing, and magnification changeover are all digitally motorized. All operations are executed via the mouse

— Both the whole image (macro image) of a specimen and the enlargement of its portion are displayed on a single screen together. Furthermore, the point being enlarged is indicated with crosshairs on the macro image.

— Memory function stores observation conditions (viewing point, magnification, aperture and brightness) with the click of the button and allows their instant recall.

— Remote operation\* and viewing of images is possible through networked computers anywhere.

— Newly developed optional ergo controller enables operation like an actual microscope.

— Images can be easily stored on a CompactFlash card or USB memory stick. Transferring them to another PC via the USB2.0 connection is also easy.

Please visit our dedicated website, where you will find extensive information on the uses and operation of the COOLSCOPE II. [www.coolscope.com](http://www.coolscope.com)

## Specifications

Main body	50i	55i
Magnification	10–1500X	
Optical system	CFI60 Infinity Optical System	
Coarse/fine focusing	Fine: 0.1mm per rotation, Coarse: 13.8mm per rotation, Minimum reading: 1 micron Coarse motion torque adjustable, Refocusing function (with stopper)	
Illumination	6V-30W halogen lamp 100-240V (worldwide voltage)	White LED array AC adapter (100-240V) or optional lithium battery (7.4V)
Built-in filter	ND8	LA60 color balance filter
Eyepiece tube	Binocular tube B (for F.O.V. 22mm) Trinocular tube F2UW (for F.O.V. 22mm/25mm, observation/photo: 100/0, 0/100) Trinocular tube T2UW (for F.O.V. 22mm/25mm, observation/photo: 100/0, 20/80, 0/100) Ergonomic binocular tube (for F.O.V. 22mm, inclination:10-30°, extension: 40mm); (when optional DSC port is attached, observation/photo: 100/0, 50/50 or 100/0, 0/100)	
Eyepiece lens	10X (F.O.V.: 22mm), 10X M photo mask (F.O.V.: 25mm), 12.5X (F.O.V.: 16mm), 15X (F.O.V.: 14.5mm), UW 10X (F.O.V.: 25mm), UW 10X M photo mask (F.O.V.: 25mm)	
Nosepiece	Sextuple nosepiece Ergo-View cytodiagnostic unit (Motorized changeover 10X to 40X with hand switch, Stamp type marking)	
Stage	— Automatic illumination adjustment with Ergo-View	
Stage	Cross travel: 54(Y) x 78(X)mm, with vernier calibrations, specimen holder for 2 slides (C-SR2)/for 1 slide (C-SR1); specimen holder opens to the left Stage handle height and torque adjustable	
Condenser focusing stroke	27mm	
Intermediate accessories	Epi-fluorescence illuminator (4 filter positions), Magnification module, Eye-level riser, Double port	
Observation method	Teaching head —	
Observation method	Brightfield, Epi-fluorescence	
Observation method	Darkfield, Phase contrast, Simple polarizing —	
Power consumption	0.9A/48W	0.2A/6W
Weight	10.4kg (binocular standard set)	9.9kg (binocular standard set)

## Dimensional Diagrams

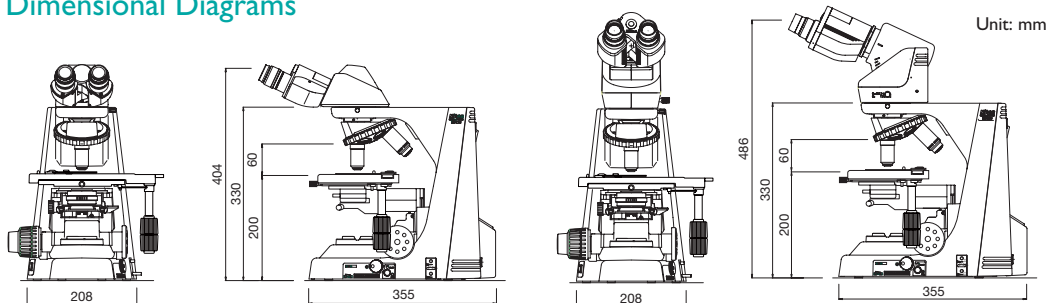

Configured with binocular tube B

Configured with ergonomic tube

Unit: mm  
Microscopy images courtesy of:  
① Nihon University Itabashi Hospital  
② Naoyuki Miyokawa, M.D., Ph.D., Associate Professor, Dept. of Surgical Pathology, Asahikawa Medical College Hospital.

Nikon has reduced the amount of chromium, cadmium and lead used in the Eclipse-i Series to an absolute minimum to diminish its environmental impact.

Please contact Nikon for a handy pamphlet listing compatible accessories, including objectives and epi-fluorescence filters.

Specifications and equipment are subject to change without any notice or obligation on the part of the manufacturer. September 2008 ©2003-8 NIKON CORPORATION

**WARNING** TO ENSURE CORRECT USAGE, READ THE CORRESPONDING MANUALS CAREFULLY BEFORE USING YOUR EQUIPMENT.

\* Monitor images are simulated.

Company names and product names appearing in this brochure are their registered trademarks or trademarks.



ISO 9001 Certified  
NIKON CORPORATION  
Instruments Company



ISO 14001 Certified  
NIKON CORPORATION  
Yokohama Plant



### NIKON CORPORATION

6-3, Nishiohi 1-chome, Shinagawa-ku, Tokyo 140-8601, Japan  
phone: +81-3-3773-8973 fax: +81-3-3773-8986  
<http://www.nikon.com/products/instruments/>

### NIKON INSTRUMENTS INC.

1300 Walt Whitman Road, Melville, N.Y. 11747-3064, U.S.A.  
phone: +1-631-547-8500; +1-800-52-NIKON (within the U.S.A. only)  
fax: +1-631-547-0306  
<http://www.nikoninstruments.com/>

### NIKON INSTRUMENTS EUROPE B.V.

Laan van Kronenburg 2, 1183 AS Amstelveen, The Netherlands  
phone: +31-20-44-96-222 fax: +31-20-44-96-298  
<http://www.nikoninstruments.eu/>

### NIKON INSTRUMENTS (SHANGHAI) CO., LTD.

CHINA phone: +86-21-5836-0050 fax: +86-21-5836-0030  
(Beijing branch) phone: +86-10-5869-2255 fax: +86-10-5869-2277  
(Guangzhou branch) phone: +86-20-3882-0552 fax: +86-20-3882-0580

### NIKON SINGAPORE PTE LTD

SINGAPORE phone: +65-6559-3618 fax: +65-6559-3668

### NIKON MALAYSIA SDN. BHD.

MALAYSIA phone: +60-3-7809-3688 fax: +60-3-7809-3633

### NIKON INSTRUMENTS KOREA CO., LTD.

KOREA phone: +82-2-2186-8410 fax: +82-2-555-4415

### NIKON CANADA INC.

CANADA phone: +1-905-602-9676 fax: +1-905-602-9953

### NIKON FRANCE S.A.S.

FRANCE phone: +33-1-4516-45-16 fax: +33-1-4516-45-55

### NIKON GMBH

GERMANY phone: +49-211-941-42-20 fax: +49-211-941-43-22

### NIKON INSTRUMENTS S.p.A.

ITALY phone: +39-055-300-96-01 fax: +39-055-30-09-93

### NIKON AG

SWITZERLAND phone: +41-43-277-28-67 fax: +41-43-277-28-61

### NIKON UK LTD.

UNITED KINGDOM phone: +44-208-247-1717 fax: +44-208-541-4584

### NIKON GMBH AUSTRIA

AUSTRIA phone: +43-1-972-6111-0 fax: +43-1-972-6111-40

### NIKON BELUX

BELGIUM phone: +32-2-705-56-65 fax: +32-2-726-66-45